



A Granning Group Brand



Panels, Mirrors, Lights

Catalogue

EDITION
02





A Granning Group Brand

United Kingdom/

36-37 Melford Court
Hardwick Grange
Warrington, Cheshire
WA1 4RZ, England

Tel +44 (0) 1925 810 400

Fax +44 (0)1925 857 085

Ireland/

Naas Industrial Estate
Naas, Co. Kildare
Ireland

Tel +353 (0) 45 875 996

Fax +353 (0) 45 894 305

Northern Ireland/

201 York Road
Belfast, BT15 3HB
Northern Ireland

Tel +44 (0) 2890 740 055

Fax +44 (0) 2890 752 718

Poland/

ul. Pułtуска 112A
07-200 Wyszaków
woj. mazowieckie
Poland

Tel +48 (0) 29 753 1616

Fax +48 (0) 29 753 1604

Export/

Naas Industrial Estate
Naas, Co. Kildare
Ireland

Tel +353 (0) 45 848 690

Fax +353 (0) 45 894 305

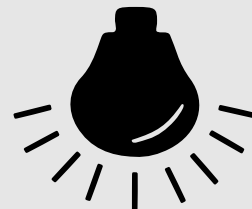

Truck

Daf, Iveco, Man, Mercedes,

Scania, Volvo

Van

Ford Transit,

Mercedes Sprinter

www.airsprings.com



Ireland +353 (0) 45 875 996
UK +44 (0) 1925 810 400
NI +44 (0) 2890 740 055
Poland +48 (0) 29 753 1616



Ireland sales@granning.ie
UK sales@granninglynx.com
NI sales@granninglynx.co.uk
Poland biuro@granning.ie



A Granning Group Brand

Online Parts / Catalogue /

visit www.airsprings.com

Airsprings.com has been developed to allow our clients to cross reference and quickly identify all parts in our product range.



www.airsprings.com



Ireland +353 (0) 45 875 996
UK +44 (0) 1925 810 400
NI +44 (0) 2890 740 055
Poland +48 (0) 29 753 1616



Ireland sales@granning.ie
UK sales@granninglynx.com
NI sales@granninglynx.co.uk
Poland biuro@granning.ie

DAF

CF85
LF45/55
XF95
XF105
XF Euro 6



MAN

TGS, TGX



MERCEDES

ACTROS MP3, MP4



SCANIA

R series (up to 2009)
R series (after 2009)



VOLVO

FH / FM 2nd series
FH / FM 3rd series
FH / FM 4th series

FORD TRANSIT

MERCEDES SPRINTER

IVECO EUROCARGO

www.airsprings.com



Ireland +353 (0) 45 875 996
UK +44 (0) 1925 810 400
NI +44 (0) 2890 740 055
Poland +48 (0) 29 753 1616



Ireland sales@granning.ie
UK sales@granninglynx.com
NI sales@granninglynx.co.uk
Poland biuro@granning.ie



Airsprings™ Part No	Page No.	Airsprings™ Part No	Page No.	Airsprings™ Part No	Page No.
24402	14	26418	6, 8	26465	18
24403	14	26419	6, 8	26467	14, 16
24628	14	26420	6, 7, 9, 10	26468	14, 16
24629	14	26421	6, 7, 9, 10	26469	22
24775	18	26427	16	26470	22
24776	18	26428	16	26471	22
25670	14, 16	26429	6, 8, 9	26472	22
25671	14, 16	26430	6, 8, 9	26473	22
25672	14, 16	26431	5, 6, 8, 9	26474	22
25673	14, 16	26432	5, 6, 8, 9	26475	22
26400	9	26435	18	26476	22
26401	9	26436	18	26477	18
26402	18, 20	26437	18	26478	14
26403	18, 20	26438	18	26479	14
26404	18, 20	26439	18	26480	5, 23
26405	18, 20	26440	18	26483	12
26406	18, 20	26441	20	26484	5, 23
26407	14, 16	26442	20	26485	5, 23
26408	14, 16	26443	20	26486	5, 23
26410	14, 16	26444	20	26487	5, 23
26411	14, 16	26445	16	26488	5, 23
26414	6, 8	26446	16	26489	23
26415	6, 7, 9, 10	26447	16	26490	23
26416	6, 7, 9, 10	26448	20	26505	22
26417	6, 8	26449	20	26506	22





Airsprings™ Part No	Page No.	Airsprings™ Part No	Page No.	Airsprings™ Part No	Page No.
27000	6	27112	15, 17	27259	19
27001	6	27113	15, 17	27260	19
27002	6	27114	15, 17	27261	19
27003	6	27122	17	27266	18
27004	6	27123	17	27267	18
27009	6	27124	15	27271	18
27010	6	27136	15, 17	27272	18
27011	6	27137	15, 17	27296	21
27012	6	27139	15, 17	27297	21
27013	6	27141	15	27518	8, 9
27035	6, 8, 9	27142	15	27519	8, 9
27036	6, 8, 9	27166	15, 17	27520	8, 9
27037	6, 8, 9	27167	15, 17	27521	8, 9
27084	10	27168	15, 17	27530	9
27085	10	27169	15, 17	27534	9
27091	10	27172	15, 17	27535	9
27092	10	27230	19	27536	8
27094	10	27231	19	27537	8
27097	10	27232	19	27539	9
27098	10	27235	18	27540	9
27100	15	27236	18	27542	11
27103	15	27241	18	27543	11
27104	15	27242	18	27544	11
27110	15	27257	18	27545	11
27111	15	27258	18	27546	11



Airsprings™ Part No	Page No.	Airsprings™ Part No	Page No.	Airsprings™ Part No	Page No.
27547	11	28350	12	28700	7, 10
27548	6, 8, 9	28351	12	28701	7, 10
27661	20	28352	12	28704	7, 10
27662	20	28359	12	28705	7, 10
27664	20	28360	12	28707	7, 10
27665	20	28361	12	28708	7, 10
27666	20	28362	12	28710	7, 10
27667	20	28363	12	28711	7, 10
27668	20	28377	12	28800	21
27669	20	28378	12	28802	21
27670	20	28383	12	28803	21
27671	20	28386	12	28812	21
27673	5	28387	12	28813	21
27674	5	28600	13	28900	14
27677	19	28601	13	28901	14
27678	19	28604	13	28902	14
27679	19	28605	13	28903	14
27680	19	28619	13	28906	16
27681	13	28623	13	28907	16
27682	13	28625	13		
27800	16	28626	13		
27802	15, 16	28636	13		
27803	15, 16	28637	13		
27900	23	28638	13		
28349	12	28639	13		



Body Panels, Mirrors, Lights



A Granning Group Brand

Body Panels, Mirrors, Lights/

Contents

DAF

LF45/55	5
CF85.....	6
CF Euro 6	7
XF95.....	8
XF105	9
XF Euro 6	10

MAN

TGX, TGS	12
----------------	----

MERCEDES

Actros MP3, MP4.....	13
----------------------	----

SCANIA

R series (up to 2009)	14
R series (after 2009)	16

VOLVO

FH, FM 2nd series.....	18
FH, FM 3rd series.....	20
FH, FM 4rd series.....	22

FORD TRANSIT	23
--------------------	----

MERCEDES SPRINTER.....	23
------------------------	----

IVECO EUROCARGO	23
-----------------------	----

OTHER / UNIVERSAL.....	23
------------------------	----

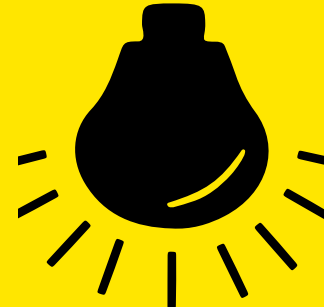
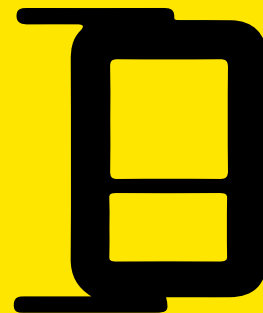
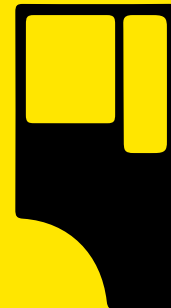

26488	-
<p>MAIN MIRROR Manual / Heated</p> 	

26487	1404868
<p>WIDE ANGLE MIRROR Manual / Heated</p> 	

26484	21020285
<p>FRONT VIEW MIRROR Manual / Non Heated</p> 	

26486	-
<p>FRONT VIEW MIRROR Manual / Heated</p> 	



26480	20849837
<p>FRONT VIEW MIRROR WITH ARM Manual / Non Heated</p> 	

26485	-
<p>FRONT VIEW MIRROR WITH ARM Manual / Heated</p> 	

26432	1699306
<p>HEADLAMP (RHS) RHD Vehicles</p>  <p>LHD Version 29801</p>	

26431	1699305
<p>HEADLAMP (LHS) RHD Vehicles</p>  <p>LHD Version 29800</p>	

27674	1400710
<p>WIND DEFLECTOR (RHS)</p> 	

27673	1400711
<p>WIND DEFLECTOR (LHS)</p> 	

BODY PANELS, MIRRORS & LIGHTS

DAF CF85



26414

1425105

MAIN MIRROR
Heated / Electric



(up to 2006)
Glass Ref - **26419**

26418

1670877

WIDE ANGLE MIRROR
Heated / Electric



(up to 2006)
Glass Ref - **26417**

26416

1689348

MAIN MIRROR
Heated / Electric



(2006 onwards)
Glass Ref - **26421**

26415

1689347

WIDE ANGLE MIRROR
Heated / Electric



(2006 onwards)
Glass Ref - **26420**

26432

1699306

HEADLAMP (RHS)
RHD Vehicles



LHD Version **29801**

26431

1699305

HEADLAMP (LHS)
RHD Vehicles



LHD Version **29800**

26429

1357075

TAIL LAMP (LHS)



26430

1625986

TAIL LAMP (RHS)



27003

1372802

HEADLAMP BRACKET SUPPORT (RHS)

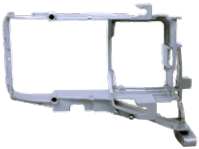

27004

1372801

HEADLAMP BRACKET SUPPORT (LHS)



27010
27011

1368837 RHS
1368836 LHS

FOOTBOARD SUPPORT



27009

0962101

STEP PLATE (RHS / LHS)



27001

1363374

HEADLAMP CORNER (RHS)



27002

1363373

HEADLAMP CORNER (LHS)



27012

1364799

FOOTBOARD (RHS)



27013

1364798

FOOTBOARD (LHS)



27000

1363375

FRONT BUMPER



27548

1371224

MUDGUARD SUPPORT



27036

1328934

REAR HALF MUDGUARD
(RHS / LHS)



Mudguard
Stretcher
27035

27037

1328935

TOP MUDGUARD
(RHS / LHS)



Mudguard
Stretcher
27035

www.airsprings.com



Ireland +353 (0) 45 875 996
UK +44 (0) 1925 810 400
NI +44 (0) 2890 740 055
Poland +48 (0) 29 753 1616



Ireland sales@granning.ie
UK sales@granninglynx.com
NI sales@granninglynx.co.uk
Poland biuro@granning.ie

26416 1689348

MAIN MIRROR
Heated / Electric



26415 1689347

WIDE ANGLE MIRROR
Heated / Electric



26421 1685330

MIRROR GLASS
Heated



26420 1685331

WIDE ANGLE MIRROR GLASS
Heated



28704 1875577

NEW PRODUCT

TAIL LAMP (LHS)
with Side Connector



28705 1875576

NEW PRODUCT

TAIL LAMP (RHS)
with Side Connector



28707 1875580

NEW PRODUCT

TAIL LAMP (LHS)
with Rear Connector



28708 1875579

NEW PRODUCT

TAIL LAMP (RHS)
with Rear Connector



28701 2032702

NEW PRODUCT

FOG LAMP (RHS)



28700 2032701

NEW PRODUCT

FOG LAMP (LHS)



28710 1914690

NEW PRODUCT

TAIL LAMP LENS (LHS)



28711 1914691

NEW PRODUCT

TAIL LAMP LENS (RHS)



BODY PANELS, MIRRORS & LIGHTS

DAF XF95

26414

1425105

MAIN MIRROR
Heated / Electric



Glass Ref - **26419**

26418

1670877

WIDE ANGLE MIRROR
Heated / Electric



Glass Ref - **26417**

26432

1699306

HEADLAMP (RHS)
RHD Vehicles



LHD Version **29801**

26431

1699305

HEADLAMP (LHS)
RHD Vehicles



LHD Version **29800**



27520

1396937

HEADLAMP SUPPORT BRACKET (RHS)



27521

1396936

HEADLAMP SUPPORT BRACKET (LHS)



26429

1357075

TAIL LAMP (LHS)



26430

1625986

TAIL LAMP (RHS)



27518

1398285

HEADLAMP CORNER HOUSING (RHS)



27519

1398284

HEADLAMP CORNER HOUSING (LHS)



27036

1328934

REAR HALF MUDGUARD
(RHS / LHS)



27037

1328935

TOP MUDGUARD
(RHS / LHS)



27537

1445564

FOOTBOARD STEP (RHS)



27536

1445563

FOOTBOARD STEP (LHS)



27548

1371224

MUDGUARD SUPPORT



27035

1340450

MUDGUARD STRETCHER



www.airsprings.com

26416 1689348

MAIN MIRROR
Heated / Electric



(2006 onwards)
Glass Ref - **26421**

26415 1689347

WIDE ANGLE MIRROR
Heated / Electric



(2006 onwards)
Glass Ref - **26420**



26432 1699306

HEADLAMP (RHS)
RHD Vehicles



LHD Version **29801**

26431 1699305

HEADLAMP (LHS)
RHD Vehicles



LHD Version **29800**

26401 1743691

XENON HEADLAMP (RHS)
RHD Vehicles



26400 1743690

XENON HEADLAMP (LHS)
RHD Vehicles



26429 1357075

TAIL LAMP (LHS)



26430 1625986

TAIL LAMP (RHS)



27520 1396937

HEADLAMP SUPPORT BRACKET
(RHS)



27521 1396936

HEADLAMP SUPPORT BRACKET
(LHS)



27540 1641631

NEW PRODUCT FOOTBOARD STEP (RHS)



27539 1641630

NEW PRODUCT FOOTBOARD STEP (LHS)



27518 1398285

HEADLAMP CORNER HOUSING (RHS)



27519 1398284

HEADLAMP CORNER HOUSING (LHS)



27534 1642683

FOOTBOARD (RHS)



27535 1642682

FOOTBOARD (LHS)



27530 1634640

FRONT BUMPER



27548 1371224

MUDGUARD SUPPORT



27036 1328934

REAR HALF MUDGUARD
(RHS / LHS)



Mudguard
Stretcher
27035

27037 1328935

TOP MUDGUARD
(RHS / LHS)



Mudguard
Stretcher
27035

BODY PANELS, MIRRORS & LIGHTS

DAF XF (Euro 6)



26416 1689348

MAIN MIRROR
Heated / Electric

26415 1689347

WIDE ANGLE MIRROR
Heated / Electric

26421 1685330

MIRROR GLASS
Heated

26420 1685331

WIDE ANGLE MIRROR GLASS
Heated

28704 1875577

NEW PRODUCT

TAIL LAMP (LHS)
with Side Connector

28705 1875576

NEW PRODUCT

TAIL LAMP (RHS)
with Side Connector

28707 1875580

NEW PRODUCT

TAIL LAMP (LHS)
with Rear Connector

28708 1875579

NEW PRODUCT

TAIL LAMP (RHS)
with Rear Connector

28701 2032702

NEW PRODUCT

FOG LAMP (RHS)

28700 2032701

NEW PRODUCT

FOG LAMP (LHS)

28710 1914690

NEW PRODUCT

TAIL LAMP LENS (LHS)

28711 1914691

NEW PRODUCT

TAIL LAMP LENS (RHS)

27097 1880379

NEW PRODUCT

FOG LAMP COVER (RHS)

27098 1880378

NEW PRODUCT

FOG LAMP COVER (LHS)

27092 1861950

NEW PRODUCT

HEADLAMP COVER (RHS)

27091 1861949

NEW PRODUCT

HEADLAMP COVER (LHS)

27084 1948244

NEW PRODUCT

FOOTBOARD (RHS)

27085 1948243

NEW PRODUCT

FOOTBOARD (LHS)

27094 1953385

NEW PRODUCT

FRONT BUMPER
(With Lamp Holes)

27543

1875550

FRONT MUDGUARD (RHS)



27544

1875549

FRONT MUDGUARD (LHS)



27545

1875554

REAR MUDGUARD (RHS)



27546

1875553

REAR MUDGUARD (LHS)



27547

1875551
1875552

TOP MUDGUARD (RHS / LHS)



27542

122035

MUDGUARD TENSIONER



BODY PANELS, MIRRORS & LIGHTS

MAN TGS, TGX

28359

81252256544

NEW PRODUCT

TAIL LAMP (LHS)
Without Number Plate Light



28360

81252256545

NEW PRODUCT

TAIL LAMP (RHS)
With Number Plate Light



28361

81252296059

NEW PRODUCT

TAIL LAMP LENS (LHS)



28362

81252296060

NEW PRODUCT

TAIL LAMP LENS (RHS)



28349

81416106750

NEW PRODUCT

HEADLAMP PANEL (RHS)



28350

81416106751

NEW PRODUCT

HEADLAMP PANEL (LHS)



28386

81416106752

NEW PRODUCT

HEADLAMP PANEL (RHS)
With Washer Hole



28387

81416106753

NEW PRODUCT

HEADLAMP PANEL (LHS)
With Washer Hole



28352

81416106754

NEW PRODUCT

SIDE BUMPER (RHS)



28351

81416106755

NEW PRODUCT

SIDE BUMPER (LHS)



28378

81416100370

NEW PRODUCT

BUMPER END PANEL (RHS)



28377

81416100369

NEW PRODUCT

BUMPER END PANEL (LHS)



28383

81416100364

NEW PRODUCT

FRONT BUMPER PANEL
(With Copper Nuts)



28363

81253206118

NEW PRODUCT

SIDE LAMP
(With Amber Bulb)



www.airsprings.com



Ireland +353 (0) 45 875 996
UK +44 (0) 1925 810 400
NI +44 (0) 2890 740 055
Poland +48 (0) 29 753 1616



Ireland sales@granning.ie
UK sales@granninglynx.com
NI sales@granninglynx.co.uk
Poland biuro@granning.ie

27681 9438110307

MIRROR ASSEMBLY (LHS)
Actros MP3 (Heated / Electric)



LHD Version
29704

27682 9438110407

MIRROR ASSEMBLY (RHS)
Actros MP3 (Heated / Electric)



LHD Version
29705

28601 9608201339

NEW PRODUCT HEADLAMP (RHD / RHS)
Actros MP4



28600 9608201239

NEW PRODUCT HEADLAMP (RHD / LHS)
Actros MP4



28605 9608201056

NEW PRODUCT LED DRL LAMP (RHS)
Actros MP4



28604 9608200956

NEW PRODUCT LED DRL LAMP (LHS)
Actros MP4



28626 9616661801

NEW PRODUCT FOOT STEP RHS
Actros MP4



28625 9616661701

NEW PRODUCT FOOT STEP LHS
Actros MP4



28637 9607510730

NEW PRODUCT CORNER PANEL INNER (RHS)
Actros MP4



28636 9607510630

NEW PRODUCT CORNER PANEL INNER (LHS)
Actros MP4



28639 9607511330

NEW PRODUCT CORNER PANEL OUTER (RHS)
Actros MP4



28638 9607511230

NEW PRODUCT CORNER PANEL OUTER (LHS)
Actros MP4



28619 9605200007

NEW PRODUCT TOP MUDGUARD
Actros MP4



28623 9605200520

NEW PRODUCT REAR MUDGUARD
Actros MP4 (Long Type)





BODY PANELS, MIRRORS & LIGHTS

SCANIA R (up to 2009)

26467 1723518
+ 1765809

MIRROR ASSEMBLY (RHD / LHS)
(Short Arm) Heated / Electric



LHD Version
29708

26468 1723519
+ 1765808

MIRROR ASSEMBLY (RHD / RHS)
(Short Arm) Heated / Electric



LHD Version
29709

26407 1765811

NEW PRODUCT MIRROR ASSEMBLY (RHD / LHS)
(Long Arm) Heated / Electric



LHD Version
29710

26408 1765813

NEW PRODUCT MIRROR ASSEMBLY (RHD / RHS)
(Long Arm) Heated / Electric



LHD Version
29711



26410 1765985

MAIN MIRROR GLASS (LHS / RHS)
(Heated)



26411 1767265

WIDE ANGLE MIRROR GLASS (LHS / RHS)
Heated



24403 1467002

HEADLAMP (RHD / RHS)



LHD Version - **29819**

24402 1467001

HEADLAMP (LHS)
RHD Vehicles



LHD Version - **29818**

28902 1385410

NEW PRODUCT INDICATOR (RHS)



28900 1387155

NEW PRODUCT INDICATOR (LHS)



28903 1385410
+ 1467007

NEW PRODUCT INDICATOR (RHS)
(With Wiring)



28901 1387155
+ 1467007

NEW PRODUCT INDICATOR (LHS)
(With Wiring)



25673 1446356

FOG LAMP (RHS)



25672 1446355

FOG LAMP (LHS)



25671 1446354

HIGH BEAM LAMP (RHS)



25670 1446353

HIGH BEAM LAMP (LHS)



26479 1371976

TAIL LAMP (LHS)
with N.Plate Light & DIN Connector



26478 1371975

TAIL LAMP (RHS)
with N.Plate Light & DIN Connector



24629 1504608

TAIL LAMP (LHS)
(no DIN connector)



LHD Version - **29822**

24628 1504609

TAIL LAMP (RHS)
(no DIN connector)



LHD Version - **29823**

www.airsprings.com



27803 1538385

NEW PRODUCT CORNER PANEL (RHS)

27802 1538384

NEW PRODUCT CORNER PANEL (LHS)

27169 1431923

NEW PRODUCT HEADLAMP UPPER EXTENSION PANEL (RHS)

27168 1431922

NEW PRODUCT HEADLAMP UPPER EXTENSION PANEL (LHS)

27141 1431921

HEADLAMP SEAT (RHS)

27142 1431920

HEADLAMP SEAT (LHS)

27139 1535048

NEW PRODUCT MIDDLE STEP PLATE (LHS / RHS)

27112 1535052

NEW PRODUCT LOWER STEP PLATE (LHS / RHS)

27113 1498180

NEW PRODUCT FOOTBOARD METAL FRAME (RHS)

27114 1498179

NEW PRODUCT FOOTBOARD METAL FRAME (LHS)

27137 1442654

NEW PRODUCT FOOTBOARD WALL COVER (RHS)

27136 1442653

NEW PRODUCT FOOTBOARD WALL COVER (LHS)

27166 1523508

NEW PRODUCT BUMPER COVER INNER High Beam Lamp Cap

27167 1523509

NEW PRODUCT BUMPER COVER OUTER Fog Lamp Cap

27103 1431926

BUMPER CORNER (RHS)

27104 1431925

BUMPER CORNER (LHS)

27110 1482404

NEW PRODUCT BATTERY COVER With Bracket

Also Available Without Bracket **27111**

27124 1496659

NEW PRODUCT EXHAUST COVER SIDE PANEL

27100 1504131

MIDDLE BUMPER

27172 1395276

TOP MUDGUARD (RHS / LHS) Low Profile

BODY PANELS, MIRRORS & LIGHTS

SCANIA R (2009 onwards)



26467 1723518
+ 1765809

MIRROR ASSEMBLY (RHD / LHS)
(Short Arm) Heated / Electric

LHD Version
29708

26468 1723519
+ 1765808

MIRROR ASSEMBLY (RHD / RHS)
(Short Arm) Heated / Electric

LHD Version
29709

26407 1765811

MIRROR ASSEMBLY (RHD / LHS)
(Long Arm) Heated / Electric

LHD Version
29710

26408 1765813

MIRROR ASSEMBLY (RHD / RHS)
(Long Arm) Heated / Electric

LHD Version
29711

26410 1765985

MAIN MIRROR GLASS (LHS / RHS)
(Heated)

26411 1767265

WIDE ANGLE MIRROR GLASS (LHS / RHS)
Heated

26446 1760555

HEADLAMP (RHS)
RHD Vehicles

LHD Version **29801**

26445 1760551

HEADLAMP (LHS)
RHD Vehicles

LHD Version **29800**

25671 1446354

HIGH BEAM LAMP (RHS)

25670 1446353

HIGH BEAM LAMP (LHS)

25673 1446356

FOG LAMP (RHS)

25672 1446355

FOG LAMP (LHS)

26427 1756754

TAIL LAMP (RHD / LHS)

26428 1756751

TAIL LAMP (RHD / RHS)

28906 2241860

NEW PRODUCT TAIL LAMP (LHS)
Models after 2013

28907 2241859

NEW PRODUCT TAIL LAMP (RHS)
Models after 2013

26447 1747981

NEW PRODUCT INDICATOR (LHS / RHS)

27800 1872158

NEW PRODUCT FRONT GRILLE PANEL
Black

27803 1538385

NEW PRODUCT CORNER PANEL (RHS)

27802 1538384

NEW PRODUCT CORNER PANEL (LHS)

www.airsprings.com

27169 1431923

NEW PRODUCT HEADLAMP UPPER EXTENSION PANEL (RHS)

27168 1431922

NEW PRODUCT HEADLAMP UPPER EXTENSION PANEL (LHS)

27137 1442654

NEW PRODUCT FOOTBOARD WALL COVER (RHS)

27136 1442653

NEW PRODUCT FOOTBOARD WALL COVER (LHS)

27113 1498180

NEW PRODUCT FOOTBOARD METAL FRAME (RHS)

27114 1498179

NEW PRODUCT FOOTBOARD METAL FRAME (LHS)



27139 1535048

NEW PRODUCT MIDDLE STEP PLATE (LHS / RHS)

27112 1535052

NEW PRODUCT LOWER STEP PLATE (LHS / RHS)

27166 1523508

NEW PRODUCT BUMPER COVER INNER High Beam Lamp Cap

27167 1523509

NEW PRODUCT BUMPER COVER OUTER Fog Lamp Cap

27122 1335391

FRONT MUDGUARD LHS Front Half / RHS Rear Half

27123 1335392

FRONT MUDGUARD LHS Rear Half / RHS Front Half

27172 1395276

TOP MUDGUARD LOW PROFILE (RHS / LHS)

BODY PANELS, MIRRORS & LIGHTS

VOLVO FH / FM (2nd series)

26402

20545581

MIRROR ASSEMBLY (LHS)
Heated / Electric



26403

20545582

MIRROR ASSEMBLY (RHS)
Heated / Electric



26404

20455986

MAIN MIRROR GLASS (LHS / RHS)
Heated / Electric



26405
26406

21320365 LHS
20589798 RHS

WIDE ANGLE MIRROR GLASS
Heated / Electric



26438

20507623

TAIL LAMP (LHS)
With Number Plate Light



26439

20507624

TAIL LAMP (RHS)
No Number Plate Light



26477

21097449

TAIL LAMP (RHS)
With Buzzer



26440

20425732

TAIL LAMP LENS (LHS / RHS)



26437

21063894

TAIL LAMP (LHS)
With Buzzer



26436

21063895

TAIL LAMP (RHS)
With Buzzer



26435

20565107

TAIL LAMP LENS



27271
27272

20409875 RHS
20409874 LHS

INDICATOR LAMP



24776

21001668

HEADLAMP (RHS)
With Round / Square Adapter



LHD Version **29826**

24775

21001663

HEADLAMP (LHS)
With Round / Square Adapter



LHD Version **29827**

27266

20826227

INDICATOR COVER (RHS)



27267

20826231

INDICATOR COVER (LHS)



27235

20453628

HEADLAMP SEAT (RHS)



27236

20453627

HEADLAMP SEAT (LHS)



27241

20452887

HEADLAMP COVER (RHS)



27242

20452886

HEADLAMP COVER (LHS)



www.airsprings.com



27678 20379176

WIND DEFLECTOR (RHS)
FH Model Only



27677 20379175

WIND DEFLECTOR (LHS)
FH Model Only



27680 20379172

WIND DEFLECTOR (RHS)
FM Model Only



27679 20379171

WIND DEFLECTOR (LHS)
FM Model Only



27230 3175417, 20425625, 20529740

MIDDLE BUMPER



27231 20529742

CORNER BUMPER (RHS)



27232 20529741

CORNER BUMPER (LHS)



27257 3175407

FOOTBOARD STEP (RHS)



27258 3175406

FOOTBOARD STEP (LHS)



27261 3171391

TOP MUDGUARD (RHS / LHS)



27259 20392544

HALF MUDGUARD (RHS / LHS)



27260 -

MUDGUARD STRETCHER



BODY PANELS, MIRRORS & LIGHTS

VOLVO FH / FM (3rd series)

26402

20545581

MIRROR ASSEMBLY (LHS)
Heated / Electric



26403

20545582

MIRROR ASSEMBLY (RHS)
Heated / Electric



26404

20455986

MAIN MIRROR GLASS (LHS / RHS)
Heated



26405
26406

21320365 LHS
20589798 RHS

WIDE ANGLE MIRROR GLASS
Heated / Electric



26449

21035637

HEADLAMP ELECTRIC (RHD RHS)



LHD Version
29828

26448

21035638

HEADLAMP ELECTRIC (RHD LHS)



LHD Version
29829

26442

21297909

FOG LAMP (RHS)



26443

21297911

FOG LAMP (LHS)



27667

82076266
8205131

HEADLAMP COVER (RHS)



27666

82076158
8205629

HEADLAMP COVER (LHS)



26441

82114500

INDICATOR LED (RHS)



26444

82114506

INDICATOR LED (LHS)



27669

82056986
8220984

HEADLAMP SEAT (RHS)



27668

82209788
8236709

HEADLAMP SEAT (LHS)



27670

82114502

INDICATOR COVER (RHS)



27671

82114504

INDICATOR COVER (LHS)



27661

21094391
21094392

FRONT HALF MUDGUARD
(RHS / LHS)



27665

21094394

REAR HALF MUDGUARD
(RHS / LHS)



27662

21094384

TOP MUDGUARD (RHS / LHS)



27664

21094457

MUDGUARD STRETCHER



www.airsprings.com



28813 82151205

NEW PRODUCT SIDE INDICATOR LAMP LED (RHS)



28812 82151157

NEW PRODUCT SIDE INDICATOR LAMP LED (LHS)



28800 82849894

NEW PRODUCT REAR LAMP (LHS) With Number Plate Light



28802 82849923

NEW PRODUCT REAR LAMP (RHS)





28803 82849905

NEW PRODUCT REAR LAMP LENS (LHS / RHS)



27296 82142373

NEW PRODUCT LOWER STEP PANEL (RHS)



27297 82141971

NEW PRODUCT LOWER STEP PANEL (LHS)



BODY PANELS, MIRRORS & LIGHTS

FORD TRANSIT

26469

4503735

MIRROR ASSEMBLY (LHS)
Heated / Electric



26470

4502152

MIRROR ASSEMBLY (RHS)
Heated / Electric



Mk6 (2000-2006)



Mk7 (2006-2013)



MERCEDES SPRINTER

26471

9068105116

MIRROR ASSEMBLY (RHD LHS)
Manual



LHD Version - **29702**

26472

9068105016

MIRROR ASSEMBLY (RHD RHS)
Manual



LHD Version - **29703**

906 (2006-2013)



26505

9068106316

NEW
PRODUCT

MIRROR ASSEMBLY (RHD LHS)
Heated / Electric



LHD Version - **29716**

26506

9068106216

NEW
PRODUCT

MIRROR ASSEMBLY (RHD RHS)
Heated / Electric



LHD Version - **29717**

26476

0028111533

MAIN MIRROR GLASS (LHS)
Heated



26475

0028111633

MAIN MIRROR GLASS (RHS)
Heated



26474

0028111933

WIDE ANGLE MIRROR GLASS (LHS)



26473

0028112033

WIDE ANGLE MIRROR GLASS (RHS)



26489	98424105
MIRROR ASSEMBLY (LHS / RHS) Manual / Non Heated	

26490	98424109
MIRROR ASSEMBLY (LHS / RHS) Manual / Heated	



DAF, RENAULT, VOLVO

26484	21020285
FRONT VIEW MIRROR Manual / Non Heated	

26486	-
FRONT VIEW MIRROR Manual / Heated	

26480	20849837
FRONT VIEW MIRROR WITH ARM Manual / Non Heated	

26485	-
FRONT VIEW MIRROR WITH ARM Manual / Heated	

26487	1404868
WIDE ANGLE MIRROR Manual / Heated	

26488	-
MAIN MIRROR Manual / Heated	

UNIVERSAL







27900	-
LED Side Marker Lamp 24V	

NEW ARRIVALS - AVAILABLE MARCH 2018





DAF LF45, LF55, XF (Euro 6)

27082	1405250	27083	1405247	27078	1945871, 1798463	27079	1945872, 1798464
FOOT STEP (RHS) DAF LF45, LF55		FOOT STEP (LHS) DAF LF45, LF55		ALLOY FOOT STEP (LHS) DAF XF106		ALLOY FOOT STEP (RHS) DAF XF106	
							
28706	1875578						
TAIL LAMP (RHS) with Side Connector & Buzzer							
							

MAN TGS TGX

28367	81611100068	28366	81611100067	28369	81611106048	28368	81611106049
OUTER CORNER PLATE (RHS)		OUTER CORNER PLATE (LHS)		INNER CORNER PLATE (RHS)		INNER CORNER PLATE (LHS)	
							
28358	81251016522	28357	81251016521	28376	81416144000		
FOG LAMP (RHS)		FOG LAMP (LHS)		FRONT PANEL RIM - CHROME			
							

MERCEDES ACTROS MP4

28603	9608201739	28602	9608201639	27684	9608103816	27683	9608103716
XENON HEADLAMP (RHS / RHS)		XENON HEADLAMP (RHS / LHS)		MIRROR ASSEMBLY (RHS) Plain Back Cover Heated / Electric		MIRROR ASSEMBLY (LHS) Plain Back Cover Heated / Electric	
							

www.airsprings.com

NEW ARRIVALS - AVAILABLE MARCH 2018

SCANIA R (2009 onwards)

28514	1923745
BUMPER CORNER (RHS)	
	

28513	1923744
BUMPER CORNER (LHS)	
	

28515	1873209
MIDDLE BUMPER	
	

27801	1872158
FRONT GRILLE PANEL White	
	

VOLVO FH / FM (4th series)

26497	-
MIRROR ASSEMBLY (LHS) Fully Heated / Electric	
	

26496	-
MIRROR ASSEMBLY (RHS) Fully Heated / Electric	
	

26502	-
MIRROR ASSEMBLY (LHS) Semi Heated / Electric (Main Glass Only)	
	

26501	-
MIRROR ASSEMBLY (RHS) Semi Heated / Electric (Main Glass Only)	
	

www.airsprings.com

Ireland +353 (0) 45 875 996
UK +44 (0) 1925 810 400
NI +44 (0) 2890 740 055
Poland +48 (0) 29 753 1616

@ Ireland sales@granning.ie
UK sales@granninglynx.com
NI sales@granninglynx.co.uk
Poland biuro@granning.ie

How to properly state the side of the vehicle based on industry standards

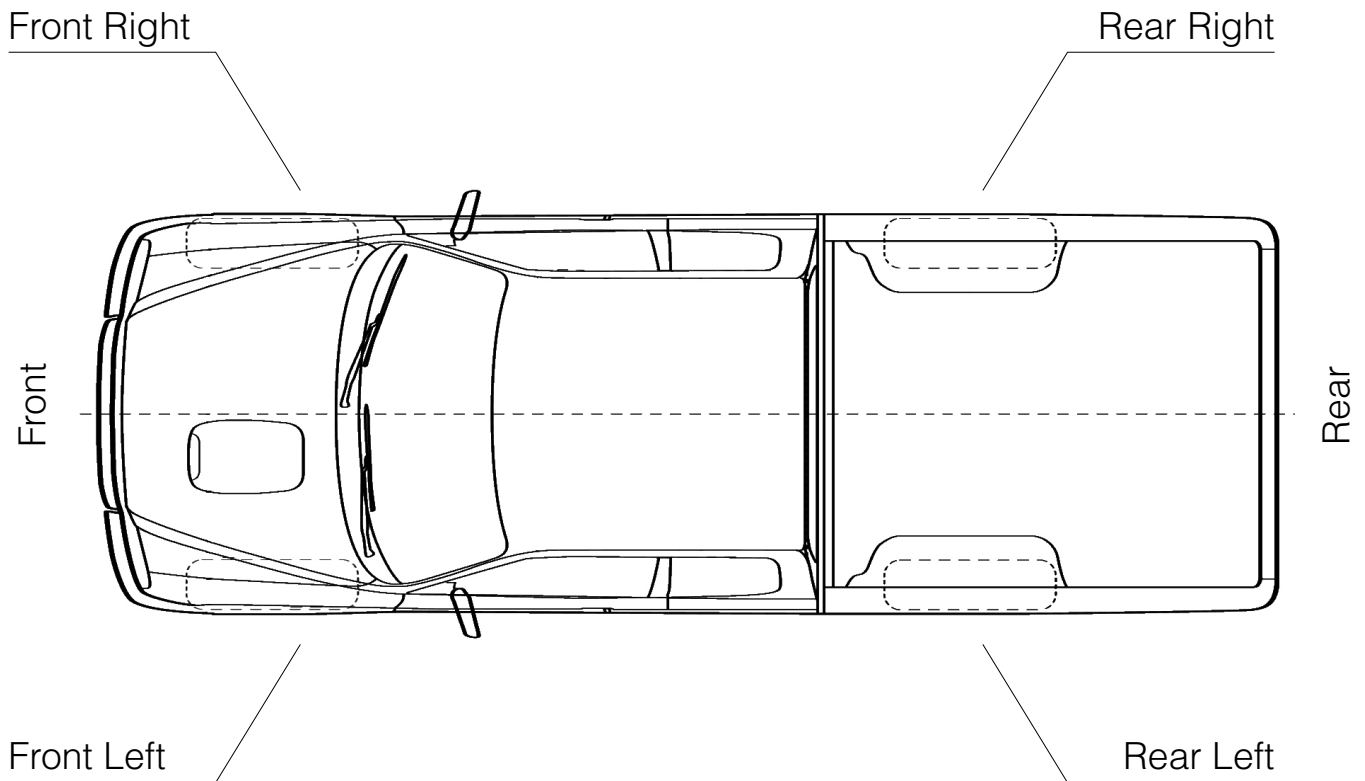



A large area of the page is filled with horizontal dotted lines, providing space for handwritten notes.

www.airsprings.com



Ireland +353 (0) 45 875 996
UK +44 (0) 1925 810 400
NI +44 (0) 2890 740 055
Poland +48 (0) 29 753 1616



Ireland sales@granning.ie
UK sales@granninglynx.com
NI sales@granninglynx.co.uk
Poland biuro@granning.ie





Area with horizontal dotted lines for writing notes.



A Granning Group Brand

Online Parts / Catalogue /

visit www.airsprings.com

Airsprings Distributors

Granning UK/

Tel +44 (0) 1925 810 400

Fax +44 (0) 1925 857 085

Granning Ireland/

Tel +353 (0) 45 875 996

Fax +353 (0) 45 894 305

Granning NI/

Tel +44 (0) 2890 740 055

Fax +44 (0) 2890 752 718

Granning Poland/

Tel +48 (0) 29 753 1616

Fax +48 (0) 29 753 1604

Granning Export/

Tel +353 (0) 45 848 690

Fax +353 (0) 45 894 305